



# Australian Government

---

## Civil Aviation Safety Authority

### RPL, PPL & CPL (Aeroplane) Workbook Version 3.0a - 02 December 2021

#### 1. CC BY- Attribution

© Civil Aviation Safety Authority



Unless noted otherwise, copyright in this work is owned by CASA.

This work is licensed under a [Creative Commons Attribution—4.0 International Licence](#), with the exception of the Commonwealth Coat of Arms; CASA's logo; any third party material; any material protected by a trademark, and any images and/or photographs.

Enquiries about this licence and any use of this work can be sent to Corporate Communications at [PublicEnquiries@casa.gov.au](mailto:PublicEnquiries@casa.gov.au).

Use of any part of this work must include the following attribution: 'Source: Civil Aviation Safety Authority'.

CASA's logo incorporates the Commonwealth Coat of Arms. Terms of use for the Coat of Arms are available from the [It's an Honour website](#).

Before using any third party material in this work, you must contact the owning party directly to seek permission to use it.

The workbook is only for use in training for the associated CASA RPL, PPL and CPL examinations, and is not to be used for any other purpose.

After use in a CASA examination, the workbook must not be removed from the examination room, but must be left with the PEXO examination Invigilator for destruction. Failure to comply with these instructions may give CASA grounds for taking action against the candidate under CAR 298A, which action could lead to the outcome indicated in CAR 298A (5).

**FOR EXAMS FROM 2 DECEMBER 2021 ONWARDS**

**TABLE OF CONTENTS**

<b>CONTENTS</b>	<b>PAGE</b>
Significant changes	3
Figs 1/2 – Aerodrome Markers/Markings	4
Fig 3 – Take-off Weight Chart	5
Fig 4 – Landing Distance Chart	6
Fig 5 – Take-off Weight Chart	7
Fig 6 – Landing Chart	8
<b>ALPHA</b>	
Loading System Alpha: Instructions	9
Fig 7 – Loading System Alpha	10
<b>BRAVO</b>	
Loading System Bravo: Instructions	11
Fig 8 – Loading System Bravo	12
<b>CHARLIE</b>	
Loading System Charlie: Instructions	13
Loading System Charlie: Index Units	14
Fig 9 – Loading System Charlie	15
<b>ECHO</b>	
Loading System Echo: Instructions	16
Loading System Echo: Instructions (continued)	17
Fig 10 – Loading System Echo: Index Units	18
Fig 11 – Loading System Echo: Centre of Gravity Envelope	19
Fig 12 – Take-off Weight Chart: Aircraft Echo	20
Fig 13 – Landing Weight Chart: Aircraft Echo	21
Scribble page	22

### Changes from version 2 introduced with this version include:

1. The introduction of cross-wind limits for take-off and landing charts.
2. A change of fuel policy to reflect CASR Part 91 or CASR Part 135 requirements.
3. The specific gravity for AVGAS of 0.72 kg/litre is used for all loading systems.

### Fuel policy information

The fuel policy for RPLA and PPLA exams will be in accordance with CASR Part 91 MOS, Chapter 19, Table 19.02 for **Aeroplane with MTOW < 5 700 kg (piston engine or turboprop)** under VFR by day.


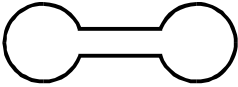
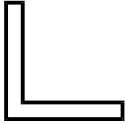
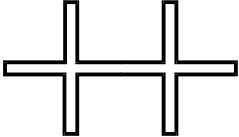
For CPL-A exams, CFPA in particular, the fuel requirements will be carried in accordance with either:

- CASR Part 91 MOS, Chapter 19, table 19.02 for **Aeroplane with MTOW < 5 700 kg (piston engine or turboprop)** under VFR by day; or
- CASR Part 135 MOS, Chapter 7.

Each question involving fuel policy decisions will clearly state whether the flight is conducted as a CASR Part 91 or Part 135 operation.



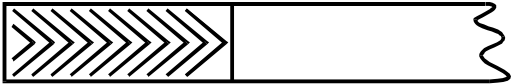

**AERODROME  
MARKERS**

**Figure 1**

- (i) 
- (ii) 
- (iii) 
- (iv) 

**AERODROME  
MARKINGS**

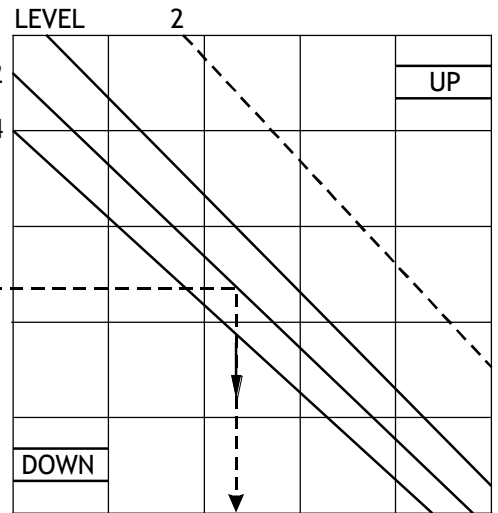
**Figure 2**

- (i)  (i)
- (ii)  (ii)
- (iii)  (iii)
- (iv)  (iv)

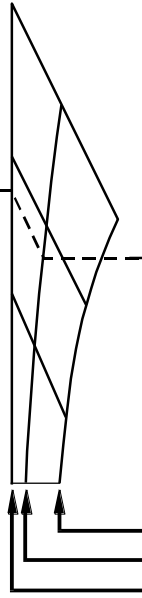
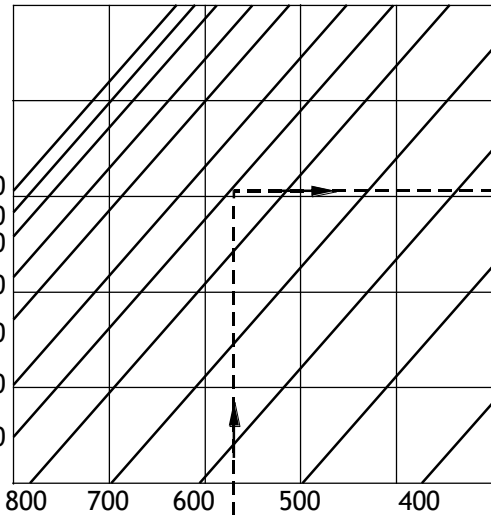
TAKE-OFF WEIGHT CHART

Figure 3

SLOPE PERCENT

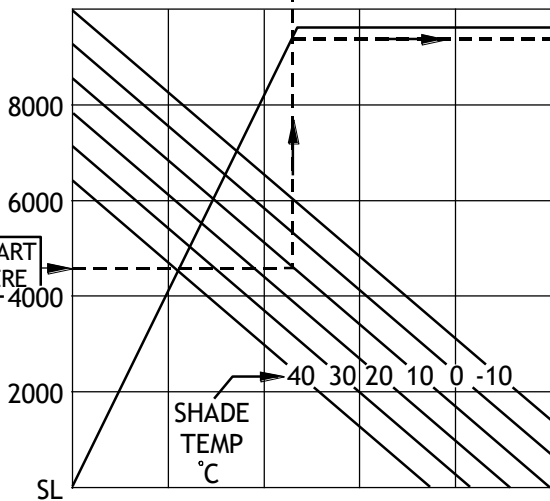


TAKE-OFF DISTANCE AVAILABLE - METRES

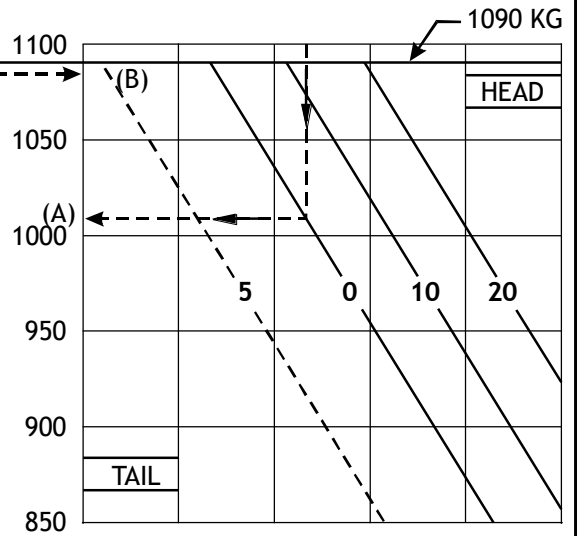


LONG WET GRASS SURFACE  
LONG DRY OR SHORT WET GRASS SURFACE  
REFERENCE LINE SHORT DRY GRASS SURFACE

AIRFIELD PRESSURE HEIGHT - FT



TAKE-OFF WEIGHT - KG



AMBIENT WIND COMPONENT - KNOTS

NOTES:

- (1) THE GROSS WEIGHT AT TAKE-OFF SHALL NOT EXCEED THE LESSOR OF (A) AND (B).
- (2) THE MAXIMUM TAKE-OFF WEIGHT = 1090 KG

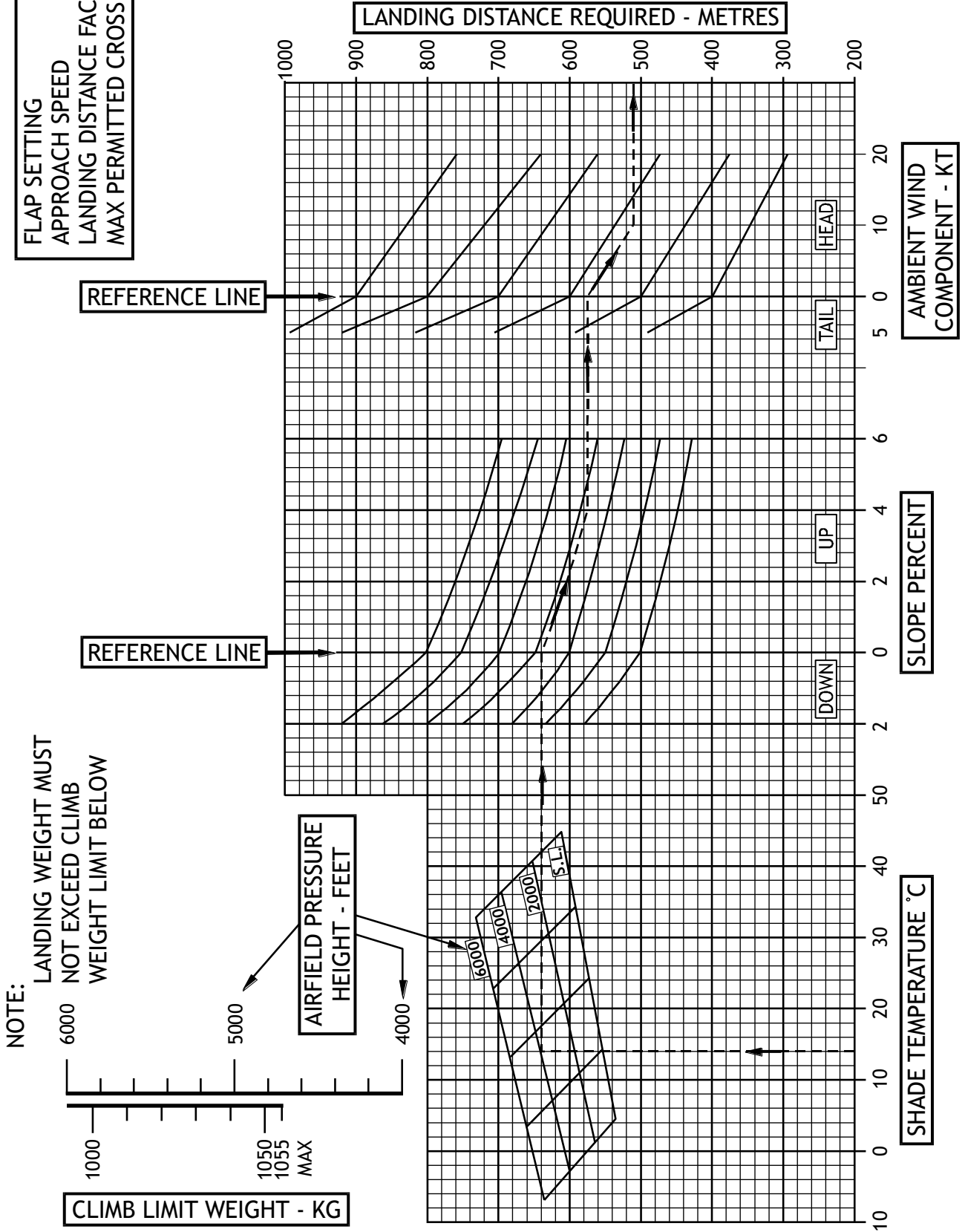
POWER TO BE USED	FULL THROTTLE
FLAP SETTING	10 DEGREES
TAKE-OFF SAFETY SPEED	60 KIAS
TAKE-OFF DISTANCE FACTOR	1.15
MAX PERMITTED CROSS WIND	15 KTS

LANDING DISTANCE CHART

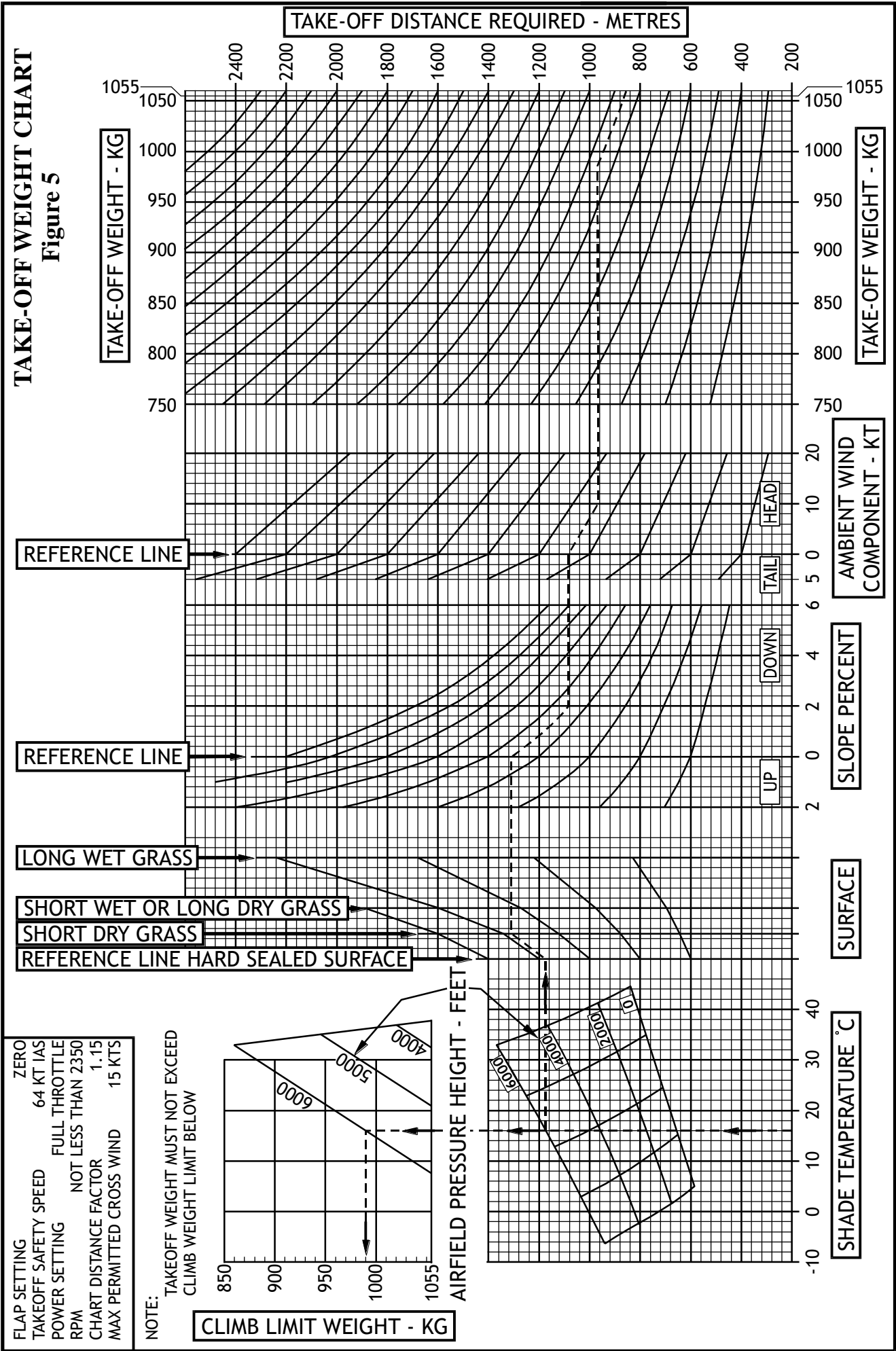
Figure 4

FLAP SETTING 40 DEGREES  
 APPROACH SPEED 65 KT IAS  
 LANDING DISTANCE FACTOR 1.15  
 MAX PERMITTED CROSS WIND 15 KTS

NOTE:  
 LANDING DISTANCE REQUIRED  
 IS INDEPENDENT OF LANDING  
 WEIGHT.



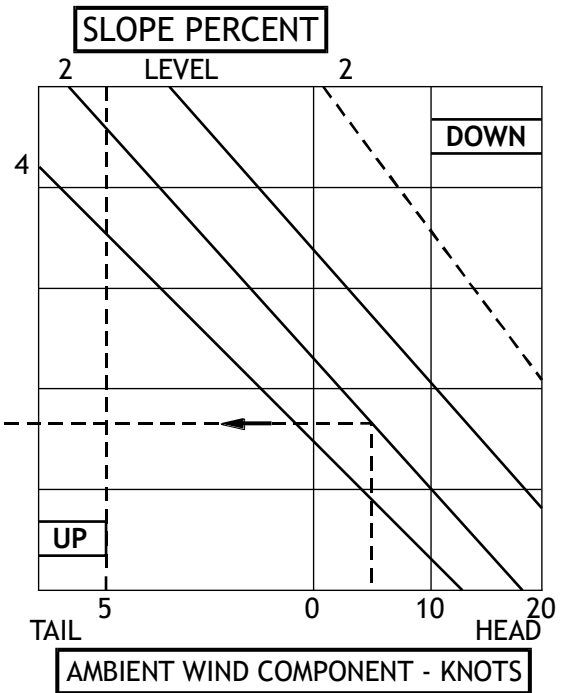
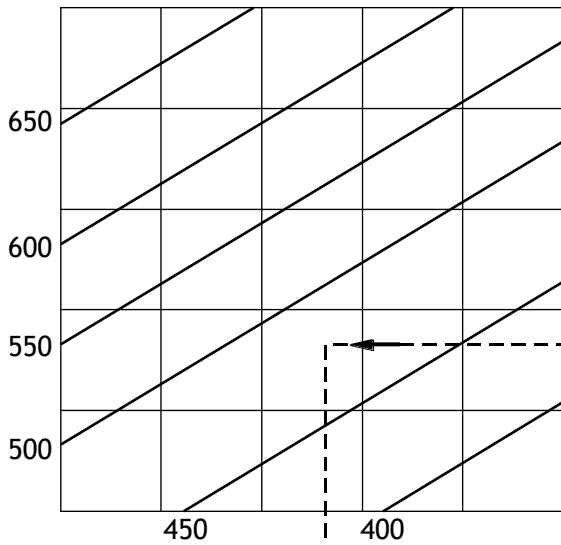
**TAKE-OFF WEIGHT CHART**  
**Figure 5**



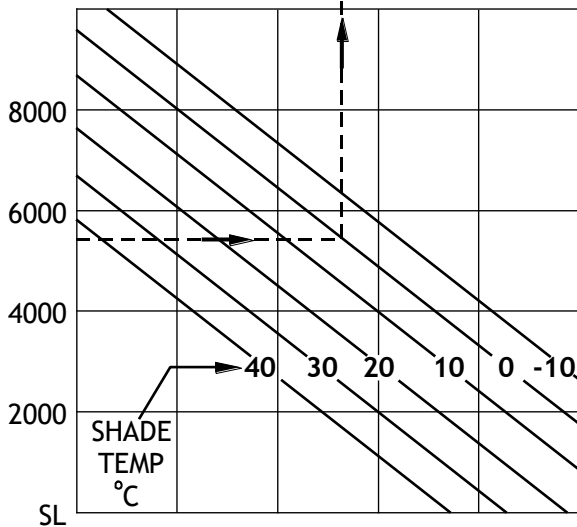
FLAP SETTING ZERO  
 TAKEOFF SAFETY SPEED 64 KT IAS  
 POWER SETTING FULL THROTTLE  
 RPM NOT LESS THAN 2350  
 CHART DISTANCE FACTOR 1.15  
 MAX PERMITTED CROSS WIND 15 KTS

**LANDING CHART**  
Figure 6

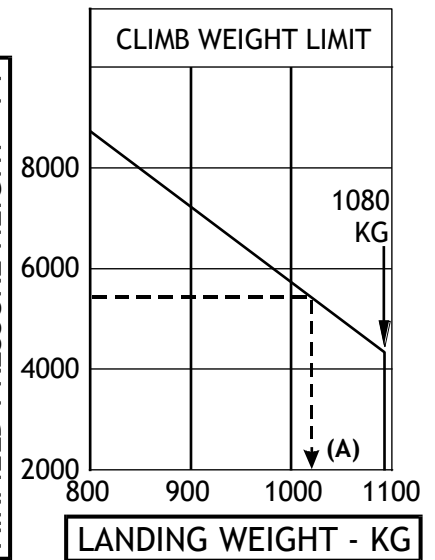
LANDING DISTANCE REQUIRED - METRES



AIRFIELD PRESSURE HEIGHT - FT



AIRFIELD PRESSURE HEIGHT - FT



NOTES:

- (1) THE GROSS WEIGHT AT LANDING SHALL NOT EXCEED (A).
- (2) LANDING DISTANCE REQUIRED DOES NOT VARY SIGNIFICANTLY WITH WEIGHT

FLAP SETTING	30 DEGREES
APPROACH SPEED	58 KIAS
LANDING DISTANCE FACTOR	1.15
MAX PERMITTED CROSS WIND	15 KTS



**LOADING SYSTEM ALPHA**  
**CONFIGURATION: 6/7 SEATS**

**INSTRUCTIONS FOR USE OF LOADING SYSTEM**

- 1 Obtain Basic Empty Weight and Index Units from current Section of 6.2 of Flight Manual.
- 2 Mark Basic Empty Weight Index Units on top scale. Enter Basic Empty Weight at top of right-hand column.
- 3 Enter weights of load items required for flight in appropriate squares of right-hand column. Maximum weights for load items are indicated on Index Unit scales.
- 4 Total weights in right-hand column to obtain Zero Fuel Weight and Take-Off Weight. \*\*
- 5 Draw horizontal lines on CG Envelope graph corresponding to Zero Fuel Weight and Take-Off Weight.
- 6 Draw a line vertically down from point marked on Basic Empty Weight Index Units scale to first load item scale.  
\* Move to the left or right on this load item index scale as per arrow directions, and mark point as appropriate to the load indicated in the right-hand column.  
(e.g. 154 KG load @ 77 KG/div. = 2 div.).
- 7 Draw a line vertically down from the point marked on the first load item index scale to the second load item index scale and continue as per \* above. Continue down the scales to “Rear Baggage”. Draw a line vertically from the “Rear Baggage” point down to intersect the Zero Fuel Weight line and Take-Off Weight line previously marked on the CG envelope graph.
- 8 The two intersection points as per 7, above must not exceed the boundaries of the CG envelope graph. If they do, re-organise the load in the aircraft and start again with steps 3 to 7.

**\*\* DO NOT EXCEED MAXIMUM TAKE-OFF WEIGHT AS SHOWN ON CG ENVELOPE DIAGRAM OF THIS LOADING SYSTEM.**

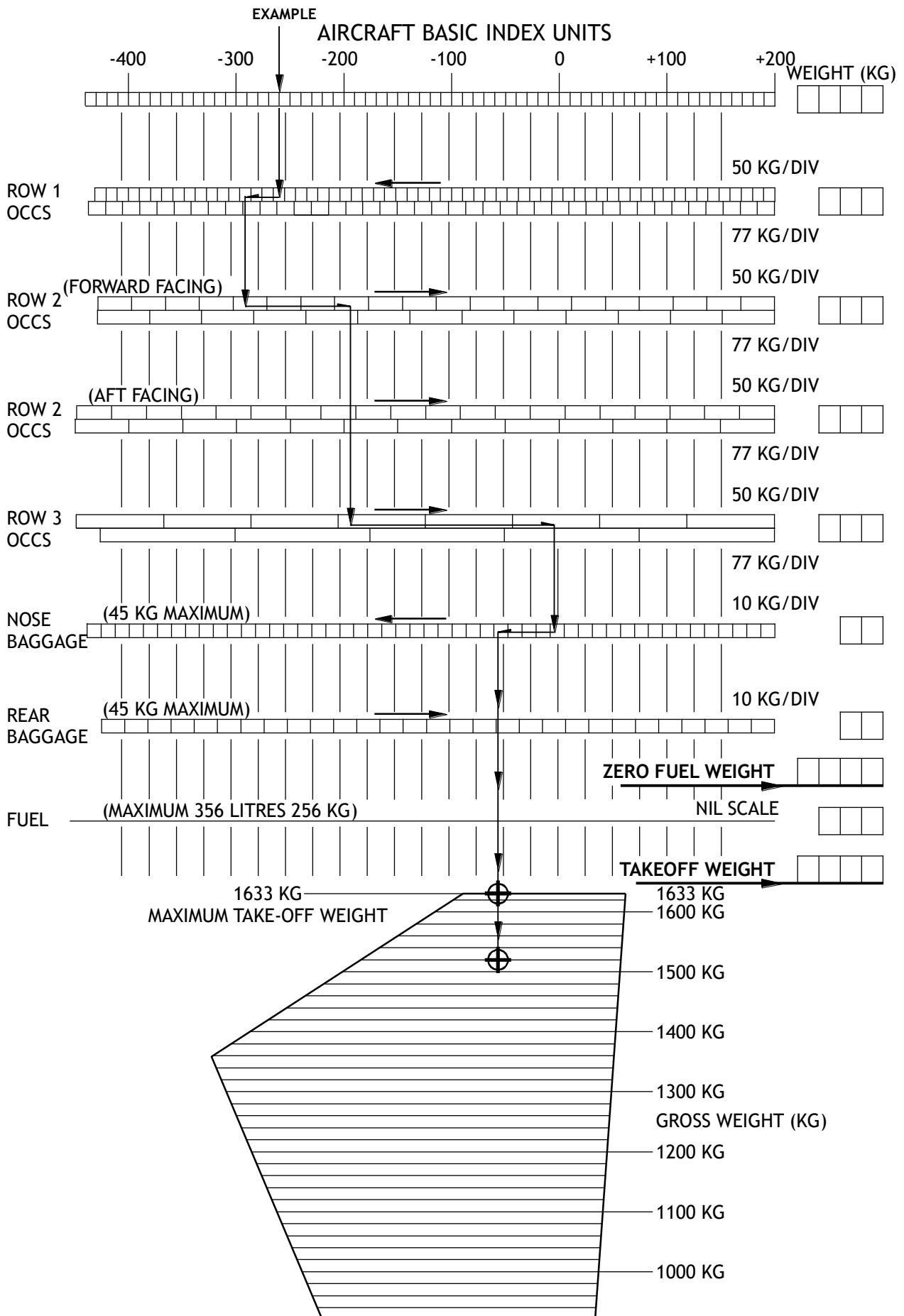
**EXAMPLE:**

Basic Empty Weight	1050 KG
Empty Index units	-260
Row 1	150 KG (2 persons)
Row 2 (forward facing)	160 KG (2 persons)
Row 3	120 KG (2 persons)
Nose baggage	40 KG ----- Zero Fuel Wt = 1520 KG
Rear baggage	Nil
Fuel	113 KG ----- Take-Off Wt = 1633 KG

**Note:** Basic Empty Weight includes unusable fuel and full oil.

LOADING SYSTEM ALPHA

Figure 7



**LOADING SYSTEM BRAVO**  
**CONFIGURATION: 4 SEATS**

**INSTRUCTIONS FOR USE OF LOADING SYSTEM**

To check the loading of the aircraft before take-off, calculate the total weight and total moments as shown in the example below.

Plot the total weight and moment on the “Centre of Gravity Envelope” chart, and if the intersection point is within the envelope, the loading is acceptable.

**AIRCRAFT LIMITATIONS**

Maximum take-off weight

Normal category: 1000 KG / 2200 lbs

Utility category: 841 KG / 1850 lbs

Maximum cargo compartment: 154 KG / 339 lbs

Maximum baggage compartment: 54 KG / 120 lbs

**Notes:**

- 1 The aircraft is fitted with standard tanks (37 US Gallons at 6 lbs / gallon)
- 2 Empty weight includes unusable fuel and undrainable oil
- 3 Obtain Moment / 1000 inch pounds from the loading graph

**EXAMPLE:**

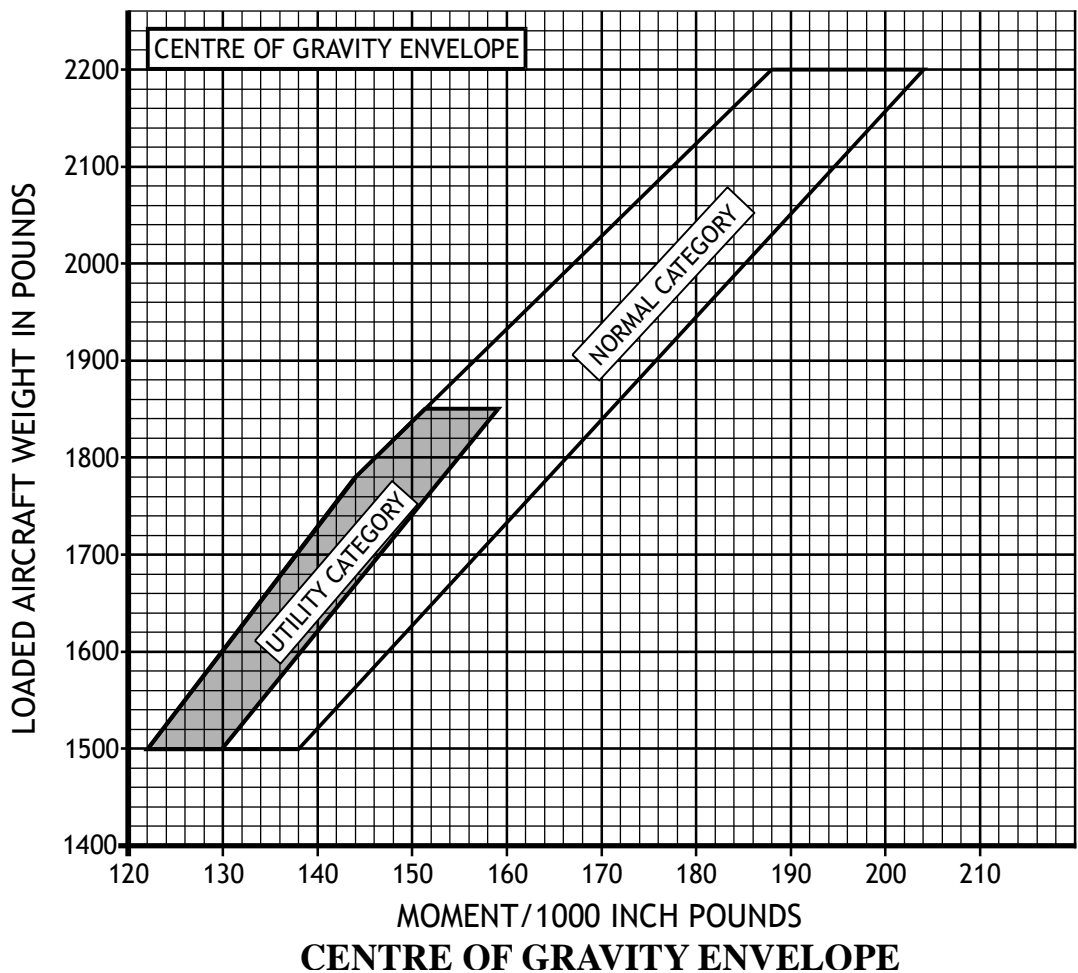
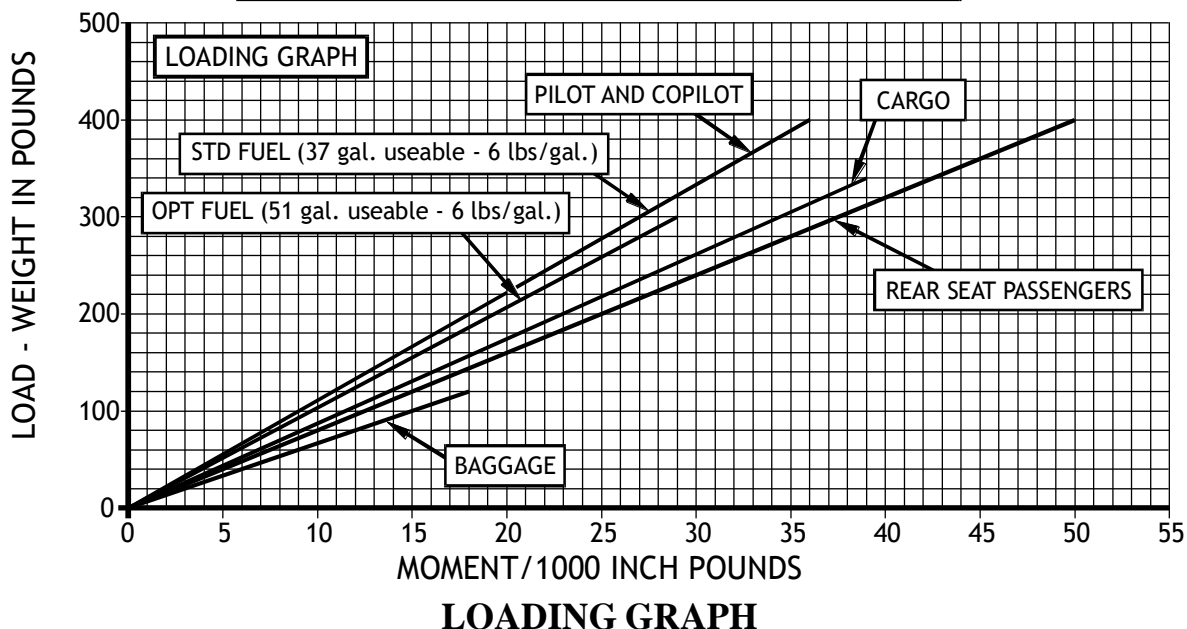
	<b>WEIGHT (LBS)</b>	<b>ARM (IN)</b>	<b>MOMENT/1000 IN LB</b>
Empty weight	1260	80	100.80
Oil	15	32	.48
Pilot & Co-Pilot	320	91	29.12
Cargo compartment	80	115	9.20
Rear seat passengers	250	126	31.50
Baggage	25	151	3.78
<b>Zero Fuel Weight</b>	<b>1950</b>		<b>174.88</b>
Fuel (140 litres)	221	91	20.11
<b>Take-Off Weight</b>	<b>2171</b>		<b>194.99</b>

**Check CG is within the envelope at both ZFW and Take-off weight**

LOADING SYSTEM BRAVO

Figure 8

Add weight of items to be carried to aeroplane licensed empty weight. Add moment/1000 of items to be carried to total aeroplane moment/1000. Use Centre of Gravity Envelope to determine acceptability.



**LOADING SYSTEM CHARLIE**  
**CONFIGURATION: 4 SEATS**

**INSTRUCTIONS FOR USE OF LOADING SYSTEM**

To check the loading of the aircraft before take-off, carry out a summation of weight and index units as shown in the example below. Check the centre of gravity of the aircraft at Zero Fuel Weight and Take-Off Weight by use of the formula:

$$\text{CG (mm aft of datum)} = \frac{\text{Index unit} \times 100}{\text{Weight}}$$

The CG must be within the envelope given at all times.

**AIRCRAFT LIMITATIONS**

Maximum take-off weight	
Normal category:	1115 KG
Utility category:	925 KG
Maximum baggage compartment baggage:	122 KG

**Notes:**

- 1 Aircraft empty weight includes unusable fuel and undrainable oil
- 2 All arms are in mm aft of datum
- 3 1 index unit = 100 KG mm

**EXAMPLE:**

	<b>KG</b>	<b>IU</b>
Aircraft empty weight	687	19,522
Full oil	7	86.1
1 pilot + 1 passenger Row 1	140	3,850
2 passengers Row 2	160	5,760
Baggage	20	842
<b>Zero Fuel Weight</b>	<b>1014</b>	<b>30,060.1</b>
Fuel 140 litres	100.8	2,973.6
<b>Take-off Weight</b>	<b>1114.8</b>	<b>33,033.7</b>

- CG check
1. At Zero Fuel Weight =  $(30,060.1 \times 100) / 1014 = 2964.51$  mm OK
  2. At Take-Off Weight =  $(33,033.7 \times 100) / 1114.8 = 2963.20$  mm OK

**LOADING SYSTEM CHARLIE****INDEX UNITS**

<b><u>Fuel @ 0.72</u></b>		<b>ARM: 2950</b>	<b><u>BAGGAGE</u></b>	<b>ARM: 4210</b>
<b>Litres</b>	<b>KG</b>	<b>Index Units</b>	<b>KG</b>	<b>Index Units</b>
20	14.40	424.80	10	421
40	28.80	849.60	20	842
60	43.20	1,274.40	30	1,263
80	57.00	1,699.20	40	1,684
100	72.00	2,124.00	50	2,105
120	86.40	2,548.80	60	2,526
140	100.80	2,973.60	70	2,947
160	115.20	3,398.40	80	3,368
180	129.60	3,823.20	90	3,789
200	144.00	4,248.00	100	4,210
216	155.52	4,587.84	110	4,631
			122	5,136

**OCCUPANTS**

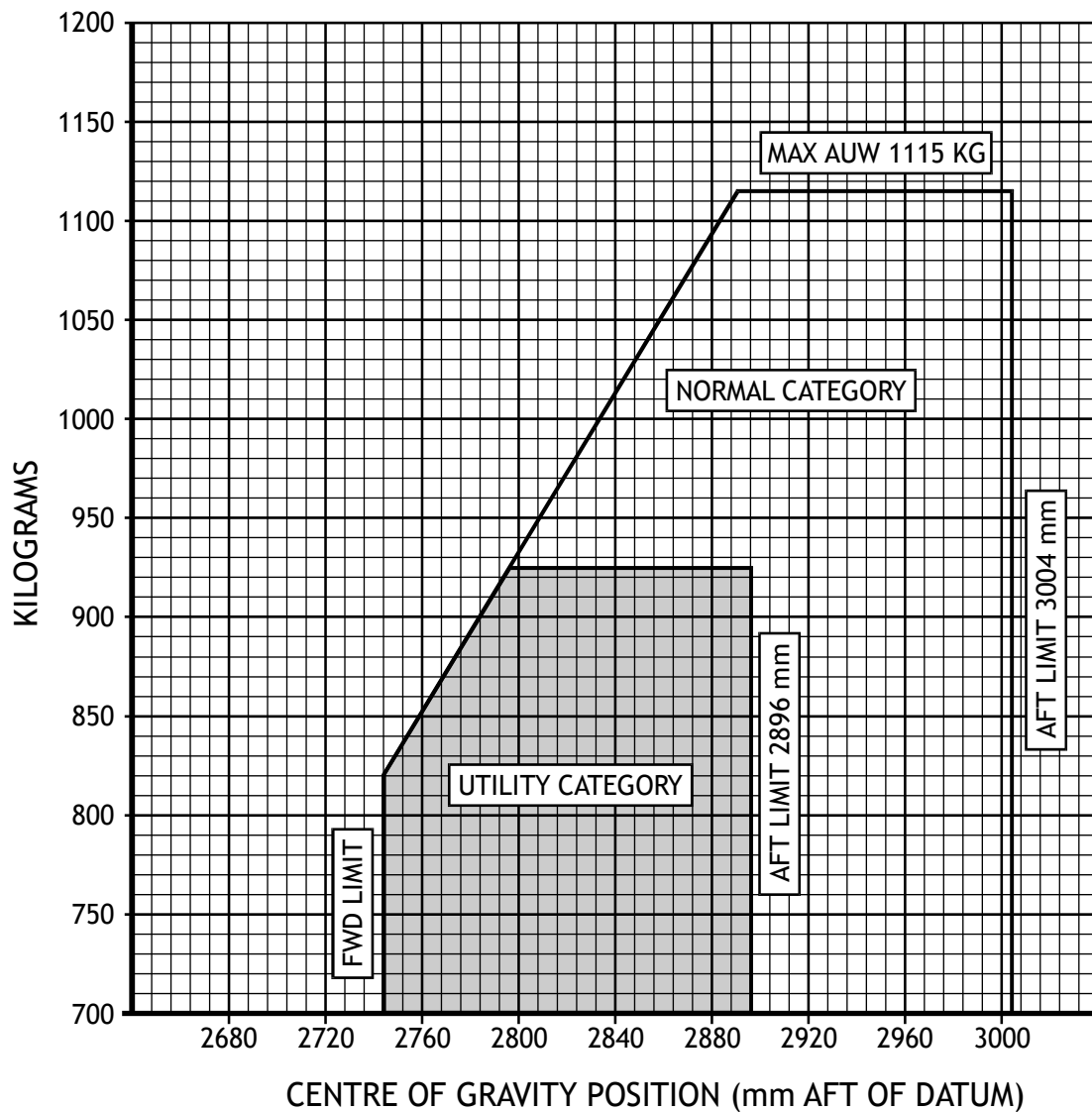
<b>KG</b>	<b>ROW 1</b>	<b>ROW 2</b>
	<b>ARM: 2750</b>	<b>ARM: 3600</b>
40	1,100	1,440
45	1,237	1,620
50	1,375	1,800
55	1,512	1,980
60	1,650	2,160
65	1,786	2,340
70	1,925	2,520
75	2,062	2,700
80	2,200	2,880
85	2,338	3,060
90	2,475	3,240

**OIL ARM: 1230**

<b>US Quarts</b>	<b>LITRES</b>	<b>KG</b>	<b>INDEX UNITS</b>
6	5.7	5.0	62
7	6.6	6.0	74
8	7.6	7.0	86

## LOADING SYSTEM CHARLIE

### Figure 9



### ALLOWABLE CENTRE OF GRAVITY ENVELOPE

#### CONVERSION FACTORS

1 inch = 25.4 mm

1 foot = 0.305 metre

1 lb = 0.454 KG

1 Imp gal = 1.201 US gal = 4.546 litres

AVGAS Specific Gravity = 0.72 Kg/Litre

**LOADING SYSTEM ECHO**  
**CONFIGURATION: 6 SEATS**

**INSTRUCTIONS FOR USE OF LOADING SYSTEM**

- 1 Moment Index chart (Figure 10, page 18) may be used to determine the balance of the aeroplane. Locate the weight (in KG) of a particular load item on the vertical scale and move horizontally to the line representing the location of that item. From that point drop vertically to read off the Moment Index for that item.
- 2 Obtain the aeroplane basic empty weight and index units from the examination question. Add up the required total weight (Gross Weight) of the aeroplane and the corresponding Total Moment Index.
- 3 Refer to the Centre of Gravity chart (Figure 11, page 19). Locate the Gross Weight of the loaded aeroplane (in KG) on the vertical scale and move horizontally to meet the vertical line representing the Total Moment Index of the loaded aeroplane. If the point of intersection, which represents the Centre of Gravity, falls in the shaded area, the aeroplane is correctly loaded.

**Note:** The Centre of Gravity must lie in the shaded area at ALL stages of flight.

<b>Weight Limitations:</b>	Maximum Take-off Weight	2950 KG
	Maximum Landing Weight	2725 KG
	Maximum Zero Fuel Weight	2630 KG

<b>Balance Data:</b>	The Mean Aerodynamic Chord (MAC) data is as follows:	
	Length of chord	1900 mm
	Location of leading edge	2190 mm aft of datum

Centre of Gravity range is as follows:  
 2400 mm to 2680 mm at 2360 KG or less  
 2560 mm to 2680 mm at 2950 KG  
 Linear variation between the points given

**Loading Data:**

<u>Location</u>	<u>Maximum Permissible Load</u>	<u>Load Arm (mm Aft of Datum)</u>
<b>Seating:</b>		
Row 1 (Seats 1 & 2)	Pilot + 1 Passenger	2290
Row 2 (Seats 3 & 4)	2 Passengers	3300
Row 3 (Seats 5 & 6)	2 Passengers	4300
<b>Cargo &amp; Baggage</b>		
<b>Compartments (Compts):</b>		
Forward Compt	55 KG	500
Left wing Compt	55 KG	3550
Right wing Compt	55 KG	3550
Rear Compt	155 KG	5000
Floor loading intensity	(All Compts) 450 KG/m <sup>2</sup>	
<b>Fuel:</b>		
Left main tank	50 gal	1780
Right main tank	50 gal	1780
Left auxiliary tank	40 gal	2800
Right auxiliary tank	40 gal	2800



**LOADING SYSTEM ECHO** (continued)

**Note:** All passenger seats weigh 5 KG each and may be removed to permit the carriage of additional cargo or baggage in the cabin.

The maximum permissible load in the area otherwise occupied by a passenger seat is 82 KG.

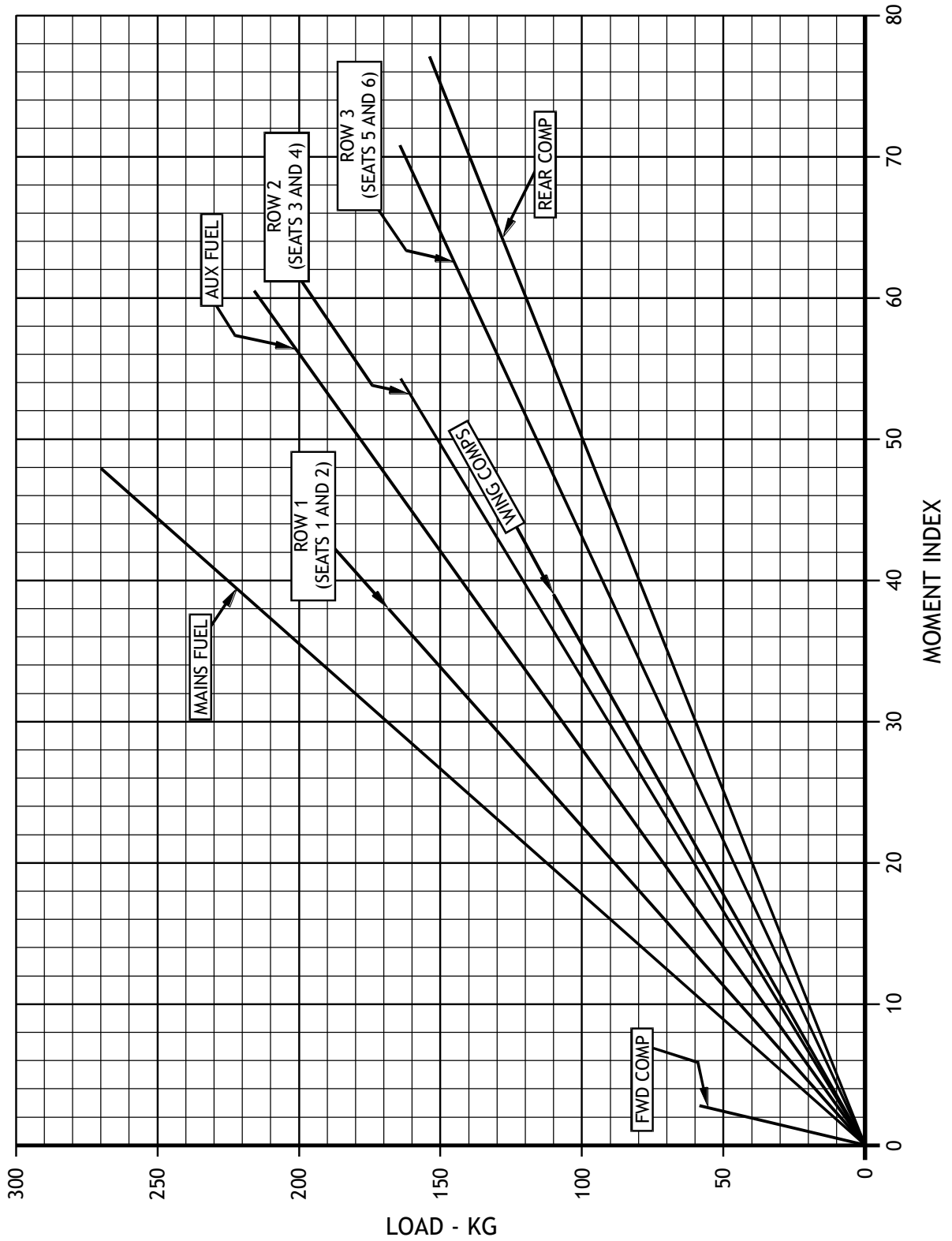
If a passenger seat is removed, adjust the empty weight and empty moment.

**EXAMPLE:**

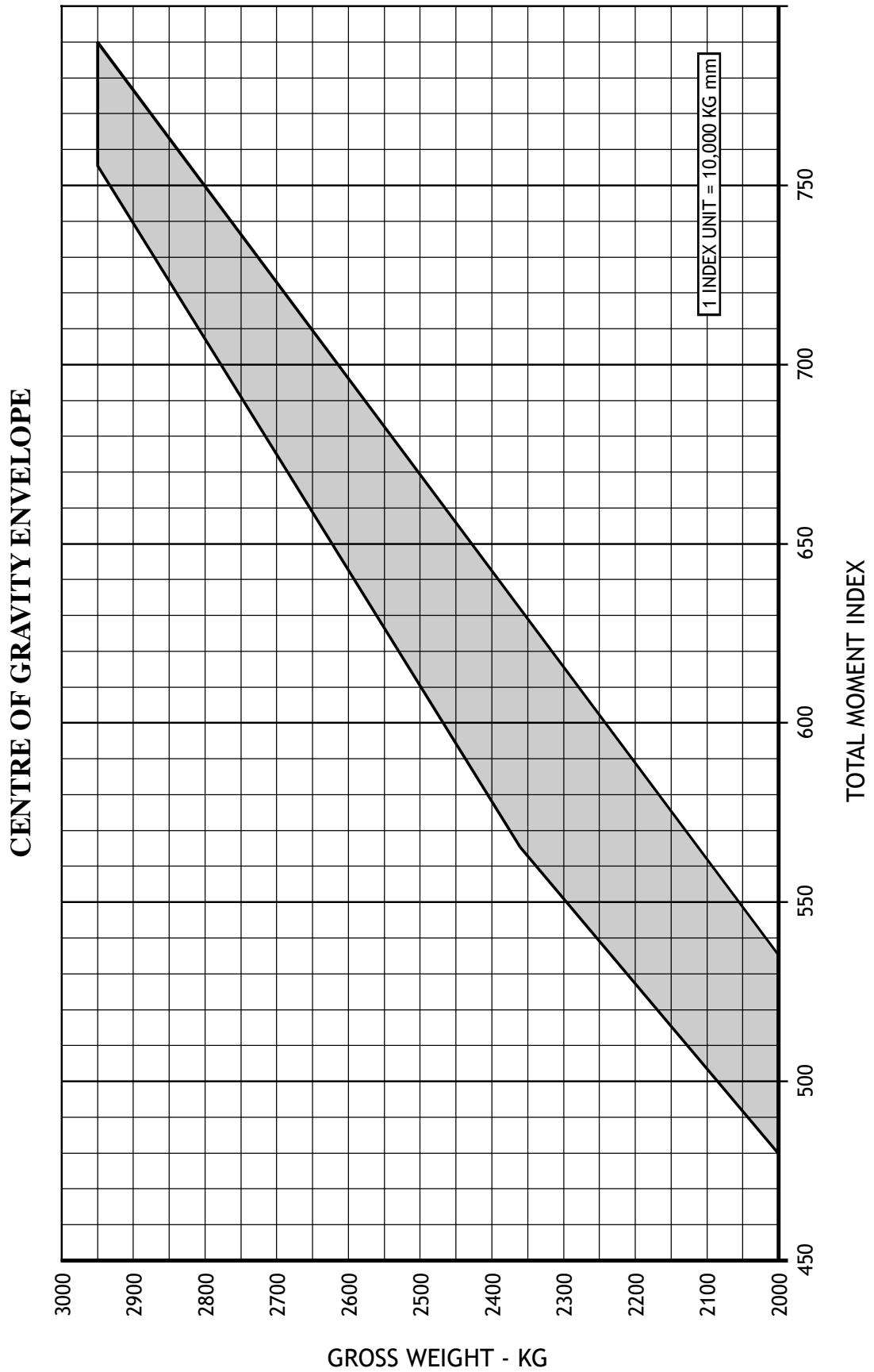
	<b>WEIGHT (KG)</b>	<b>MOMENT INDEX</b> (Refer to Figure 10)
Aeroplane Basic Empty Weight	1970	478.0
Row 1 (2 passengers)	150	34.0
Row 2 (2 passengers)	140	46.3
Row 3 (2 passengers)	130	56.0
Rear compartment	100	50.0
<b>Zero Fuel Weight</b>	<b>2490</b>	<b>664.3</b>
Fuel in Main tanks	200	35.5
<b>Take-off Weight</b>	<b>2690</b>	<b>699.8</b>
Fuel Burn-off	80	14.3
<b>Landing Weight</b>	<b>2610</b>	<b>685.5</b>

Refer to the Centre of Gravity Chart (Figure 11, page 19) to assess whether the horizontal line from the “Gross Weight” in question intersects the vertical line from its corresponding Total Moment Index in the shaded area.

LOADING SYSTEM ECHO  
Figure 10

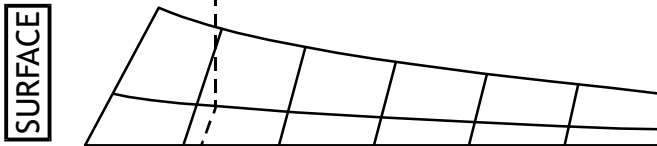
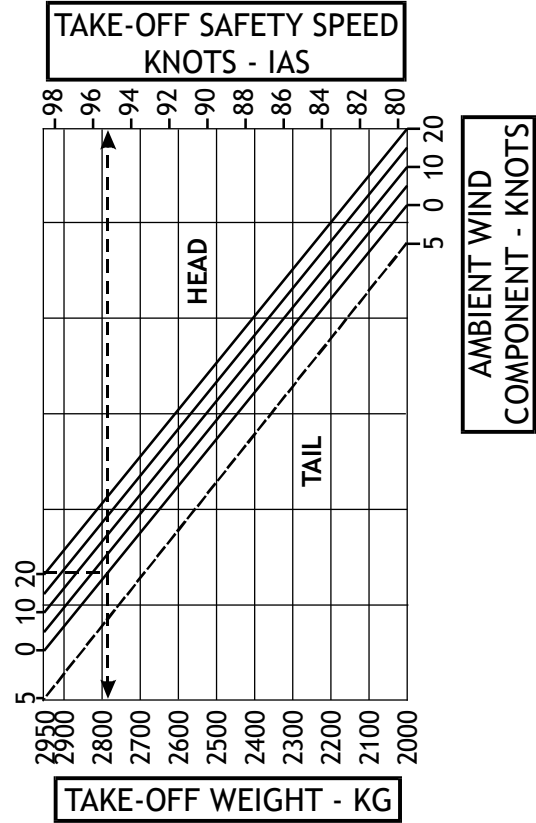
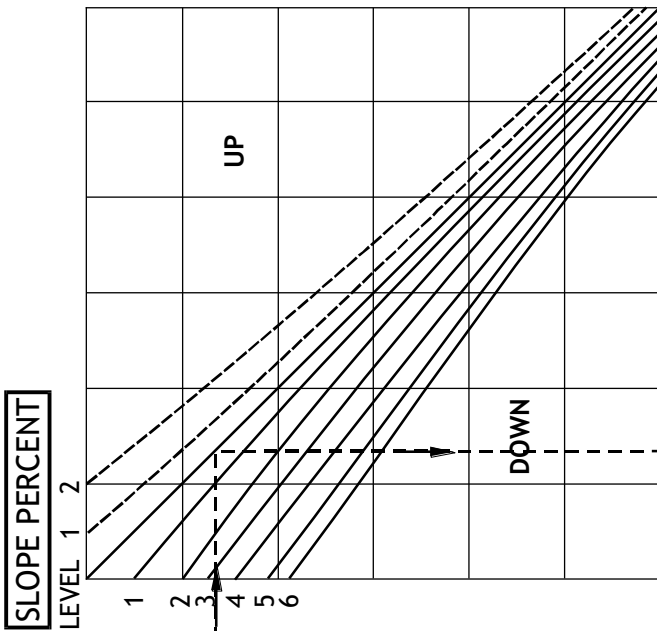


LOADING SYSTEM ECHO  
Figure 11

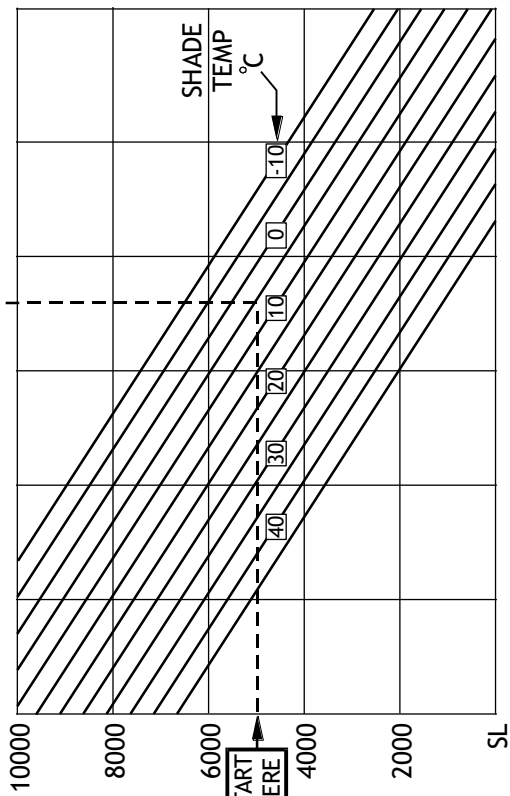
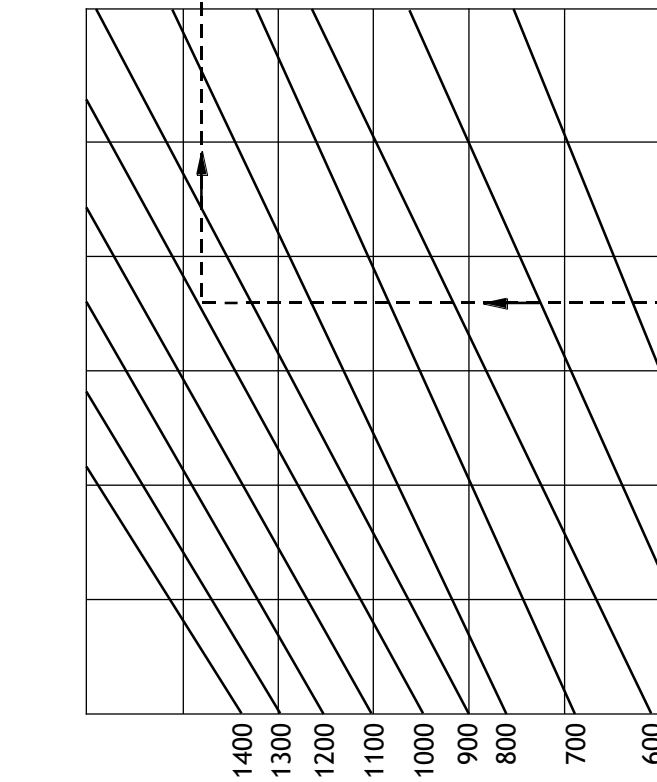


FLAP SETTING	ZERO DEGREES
TAKE-OFF SAFETY SPEED	SEE SCALE
DISTANCE FACTOR	1.22
POWER TO BE USED	RPM 3200 RPM
	MAN PRESS 37.4 IN Hg
MAX PERMITTED CROSS WIND	20 KTS

**TAKE-OFF WEIGHT CHART**  
**AIRCRAFT - ECHO Figure 12**



LONG WET GRASS  
SHORT WET OR LONG DRY GRASS  
REFERENCE LINE - SHORT DRY GRASS



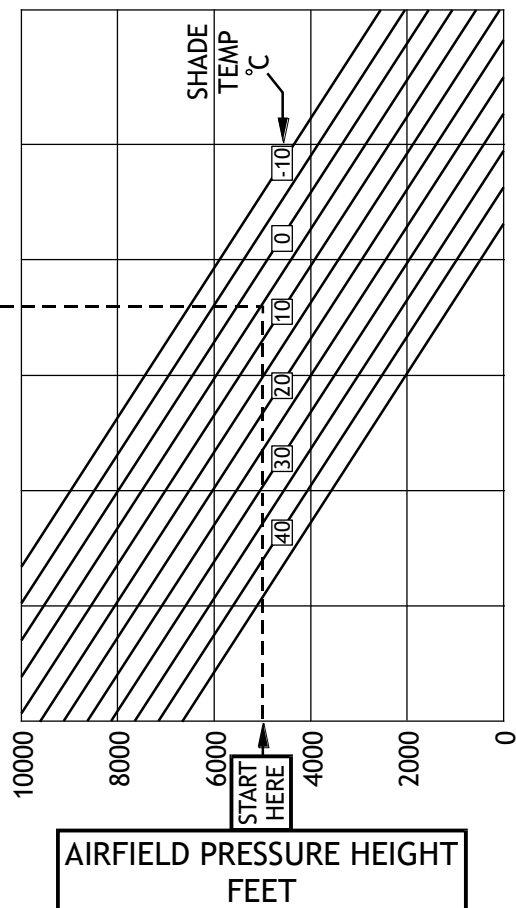
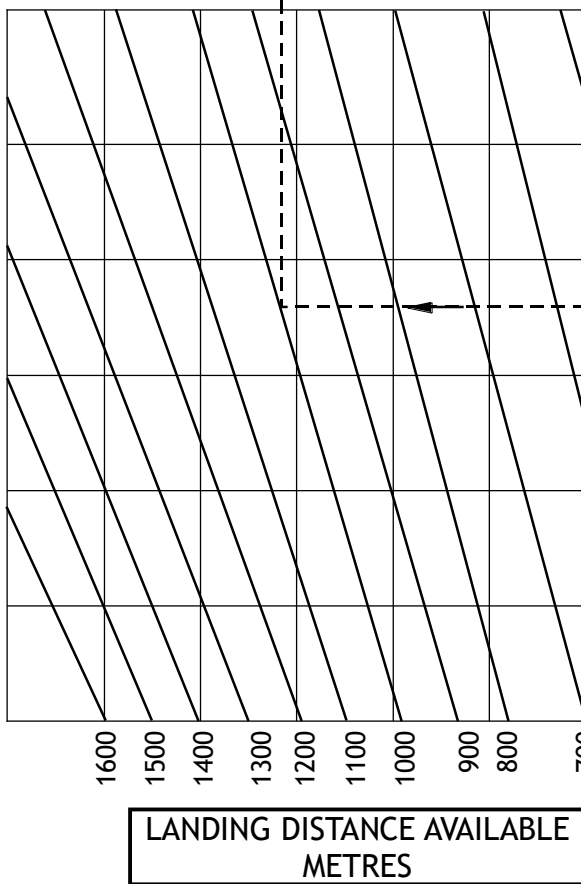
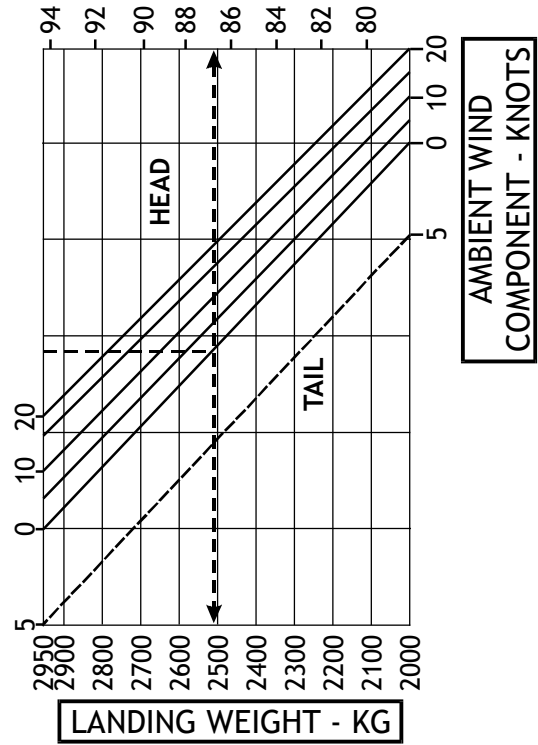
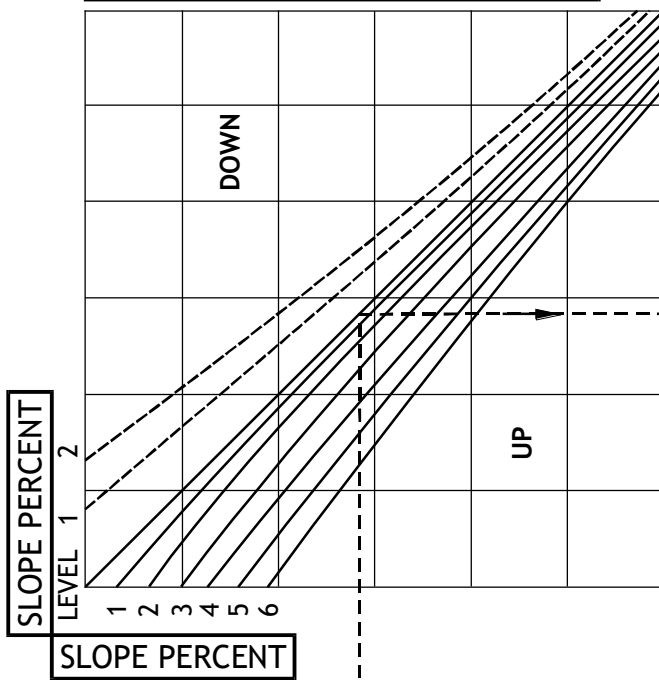
TAKE-OFF DISTANCE AVAILABLE - METRES

AIRFIELD PRESSURE HEIGHT - FEET

**LANDING WEIGHT CHART**  
**AIRCRAFT - ECHO**  
**Figure 13**

FLAP SETTING 45 DEGREES  
 APPROACH SPEED SEE SCALE  
 DISTANCE FACTOR 1.26  
 MAX PERMITTED CROSS WIND 20 KTS

APPROACH SPEED  
 KNOTS - IAS







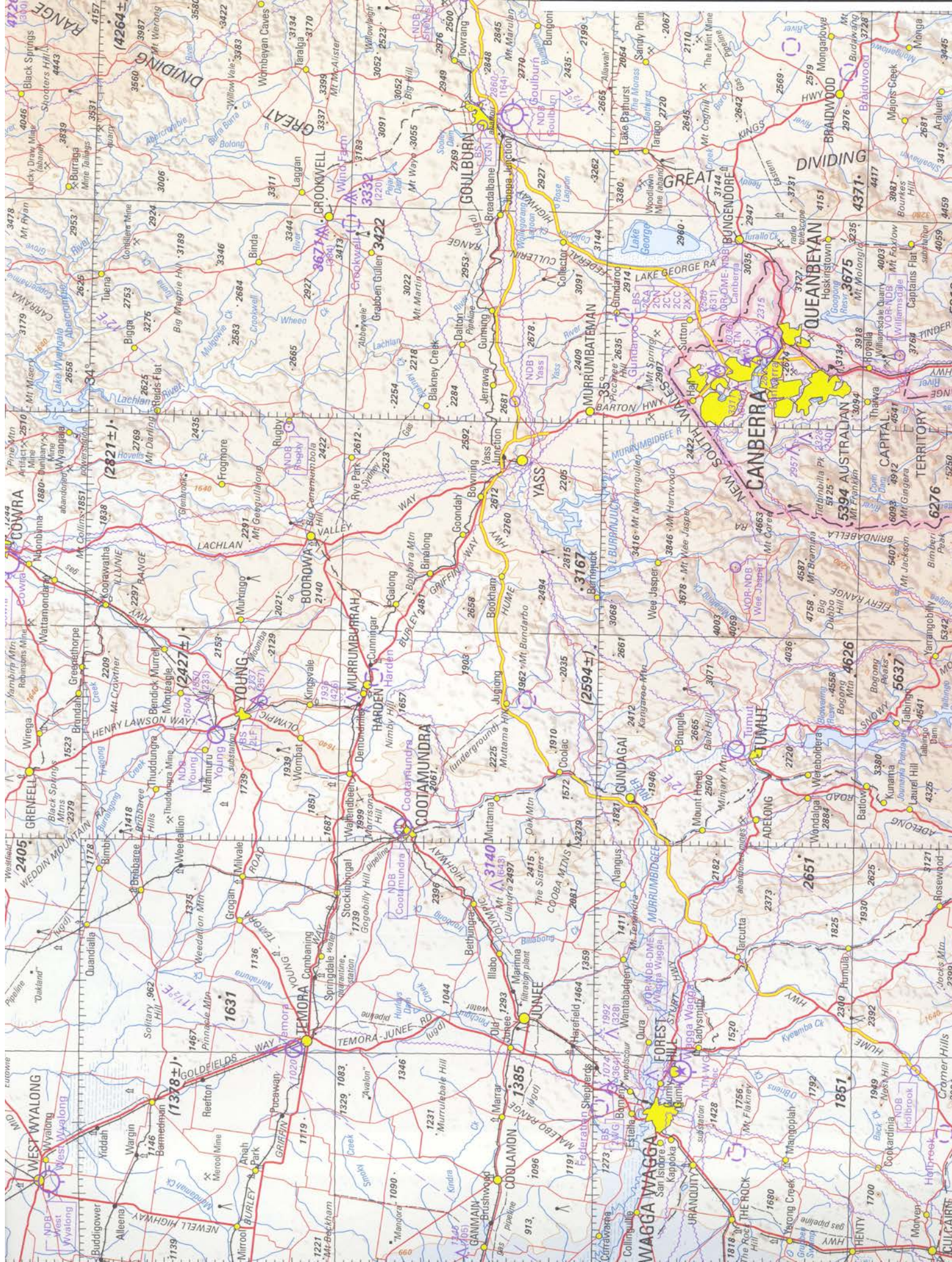






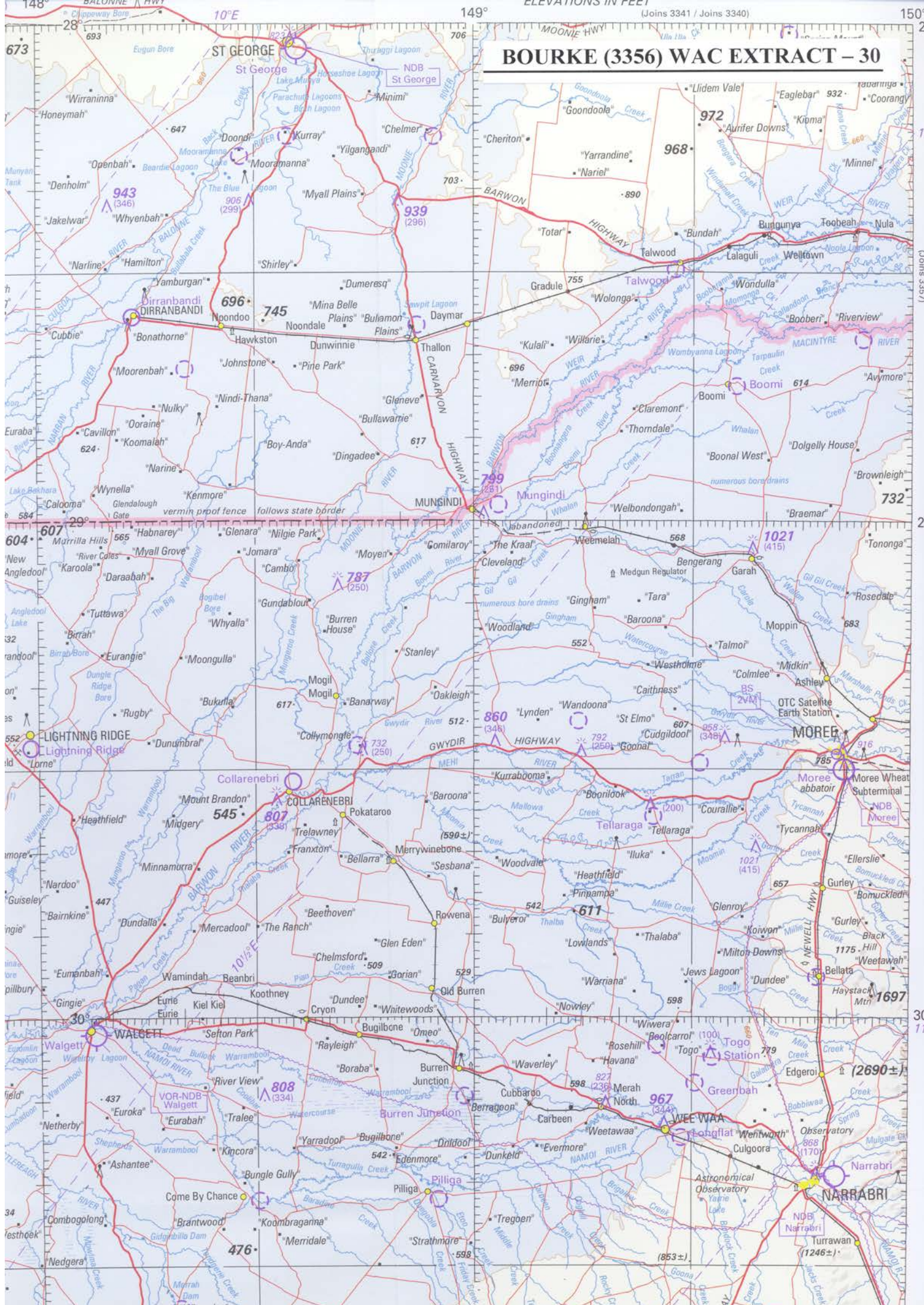


# SYDNEY (3456) WAC EXTRACT - 29





**BOURKE (3356) WAC EXTRACT - 30**



ELEVATIONS IN FEET

(Joins 3341 / Joins 3340)

(Joins 3357)

29

30

11°



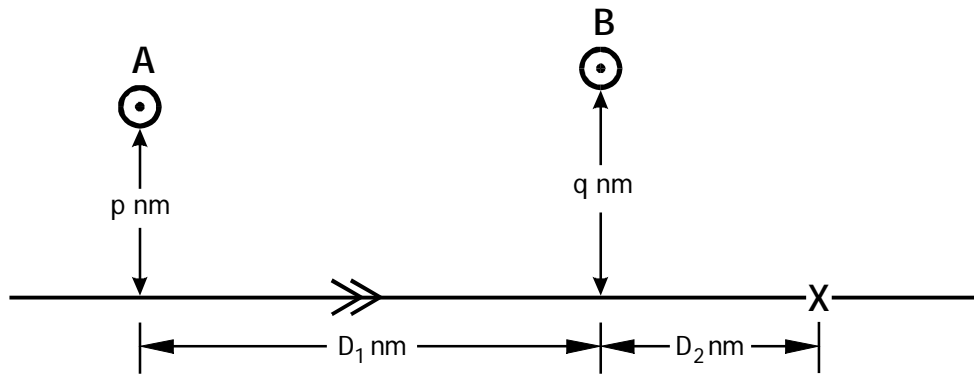


Figure 16

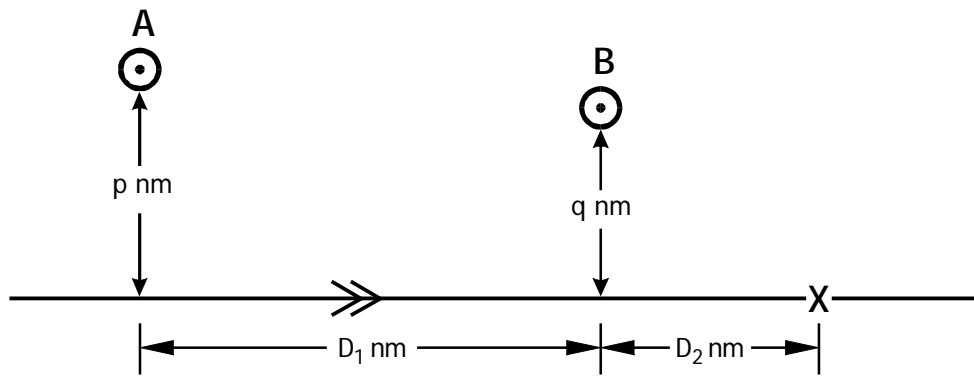


Figure 17

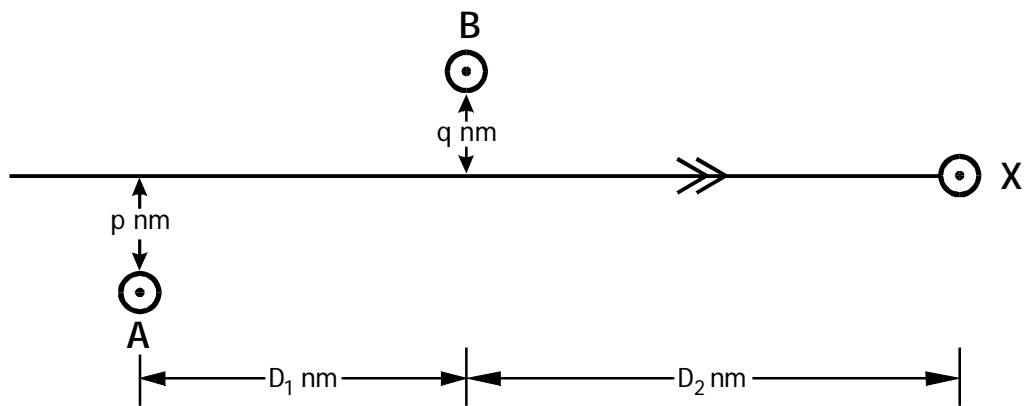


Figure 18

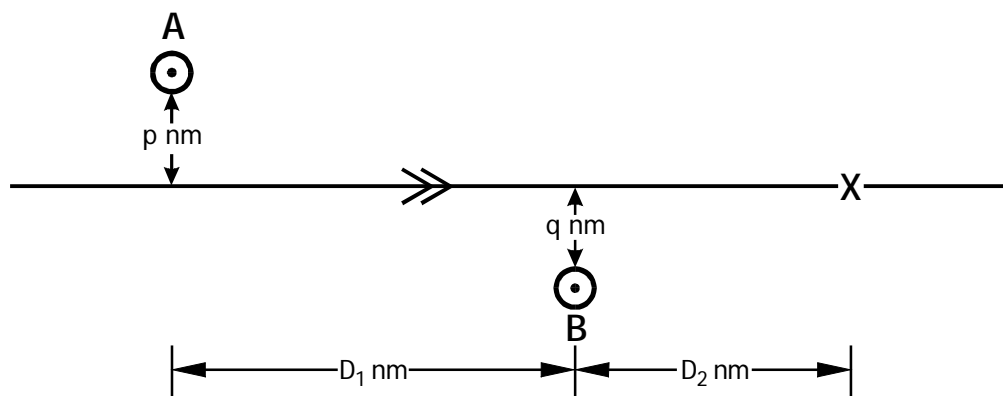


Figure 19

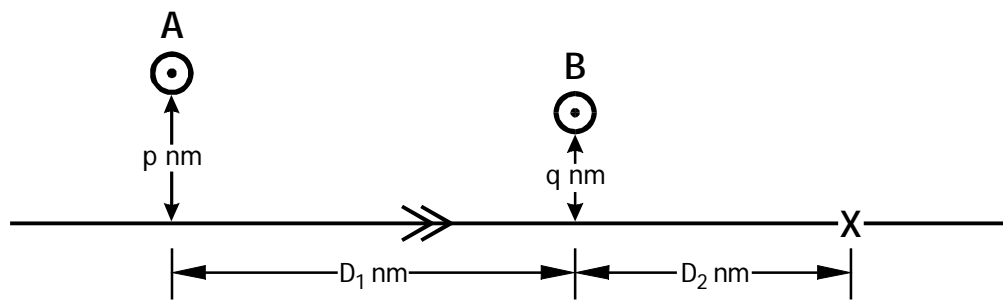


Figure 20

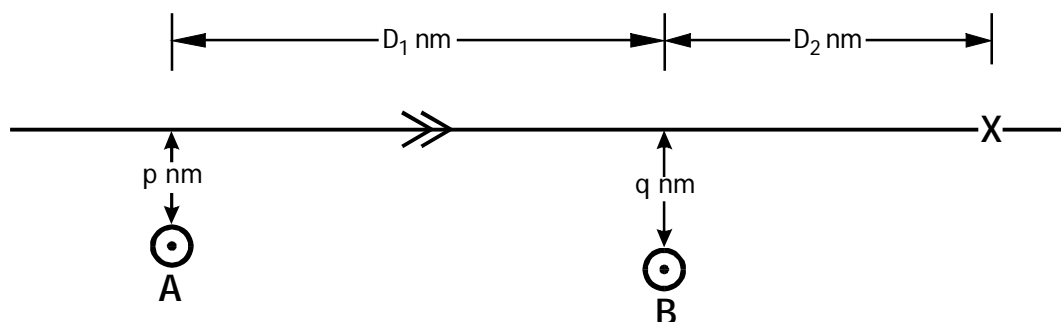


Figure 21

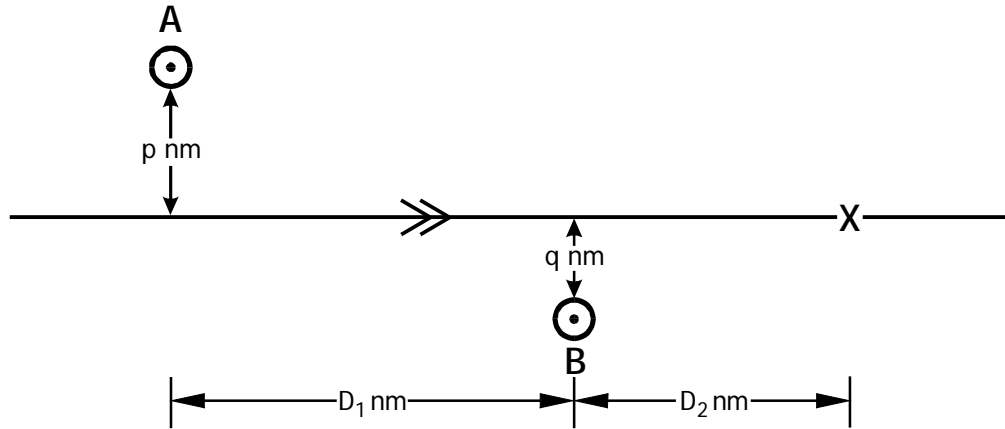


Figure 22

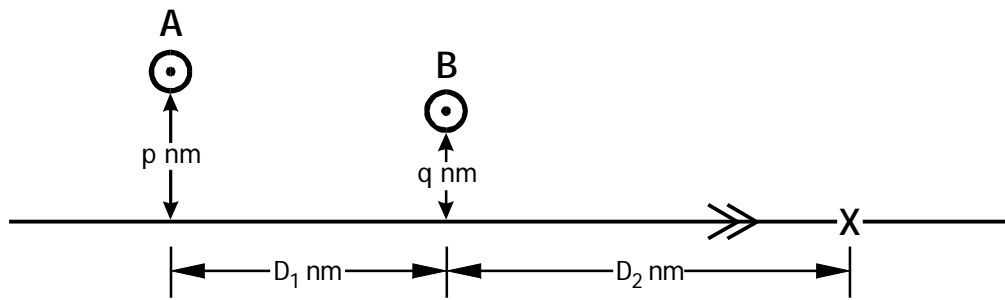


Figure 23

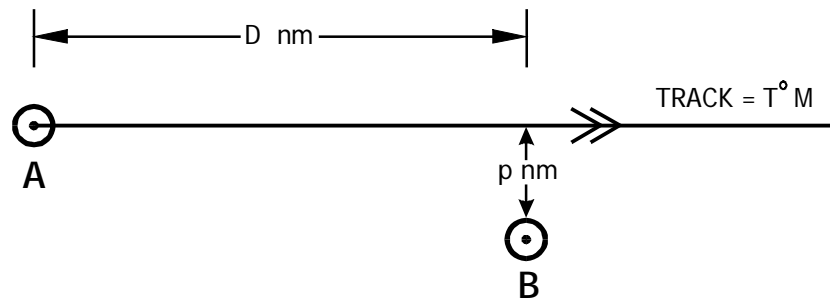
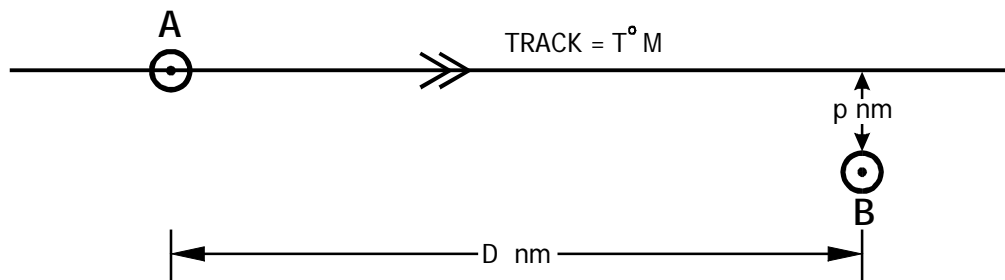
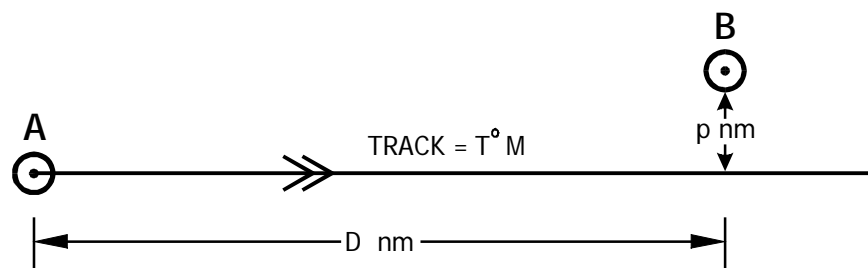


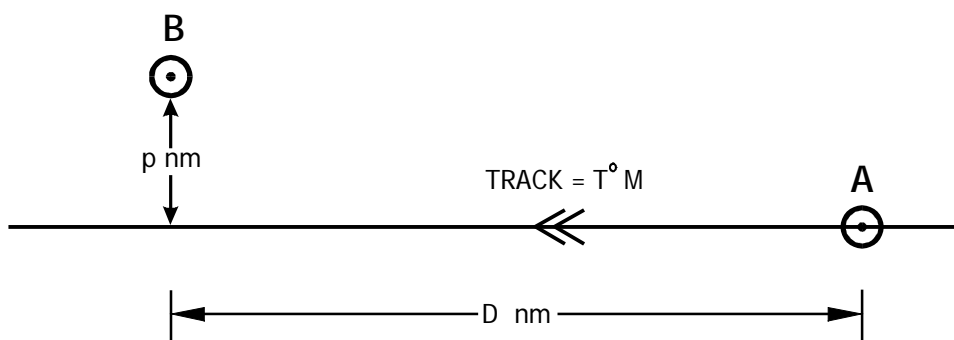
Figure 24



**Figure 25**



**Figure 26**



**Figure 27**

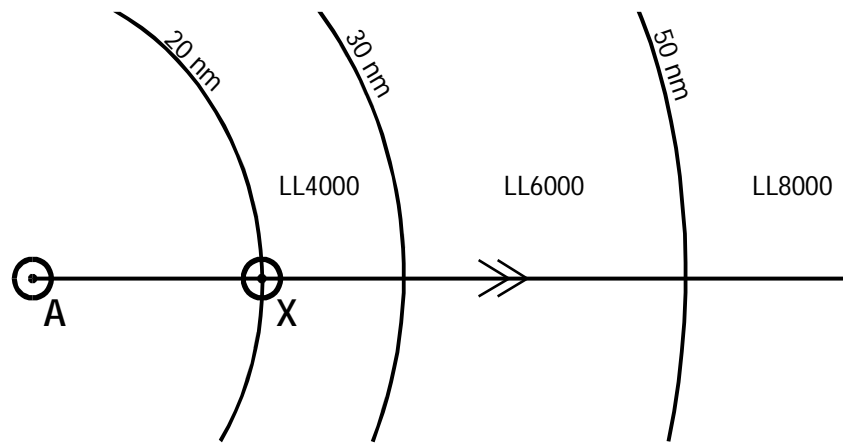


Figure 28

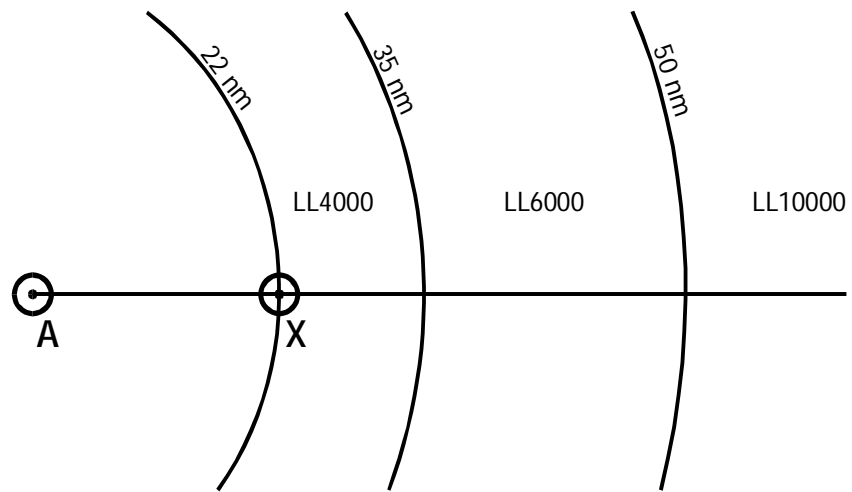


Figure 29

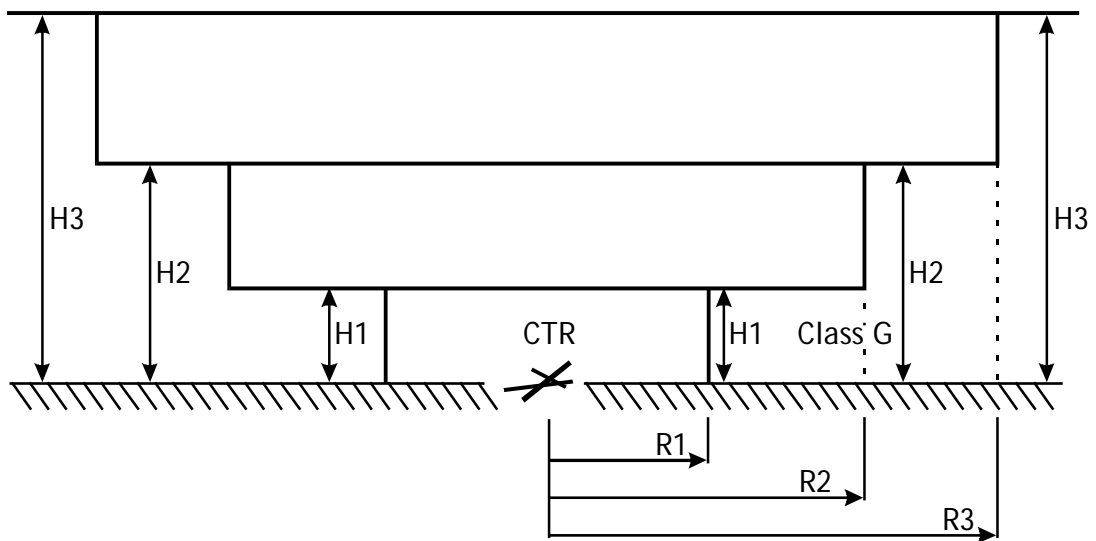
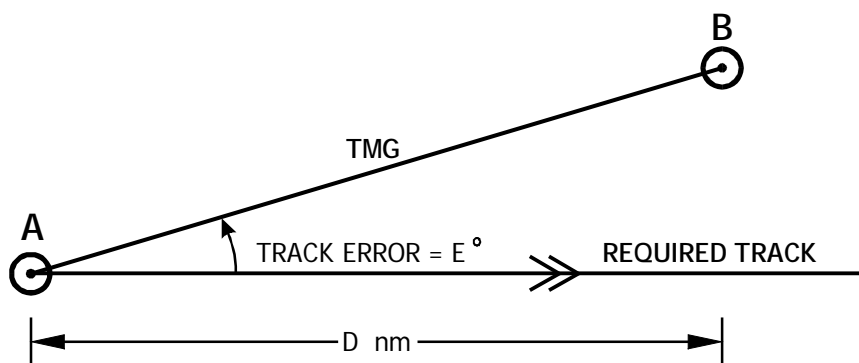
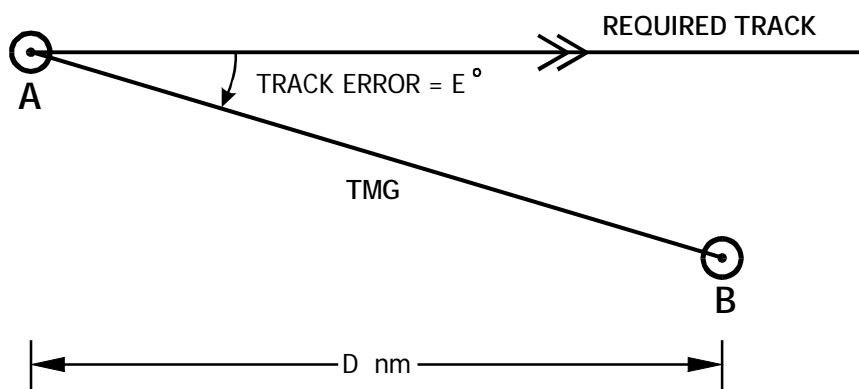


Figure 29A

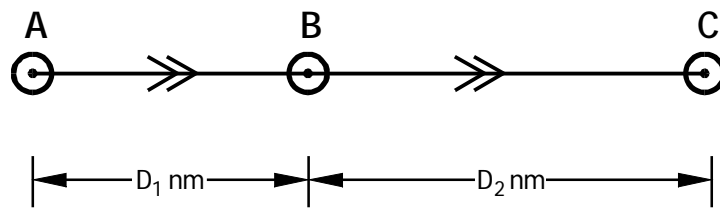


**Figure 30**

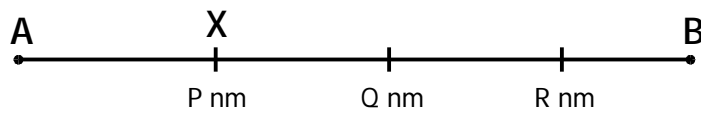


**Figure 31**

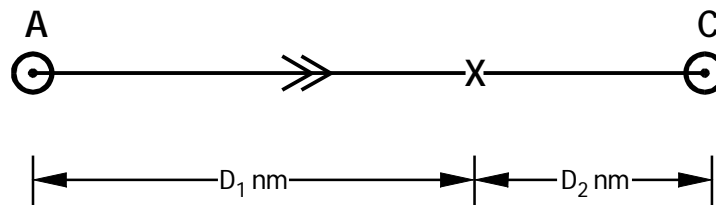




**Figure 32**



**Figure 33**



**Figure 34**

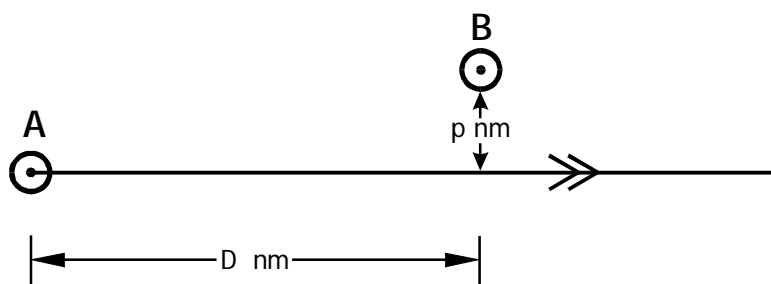


Figure 35

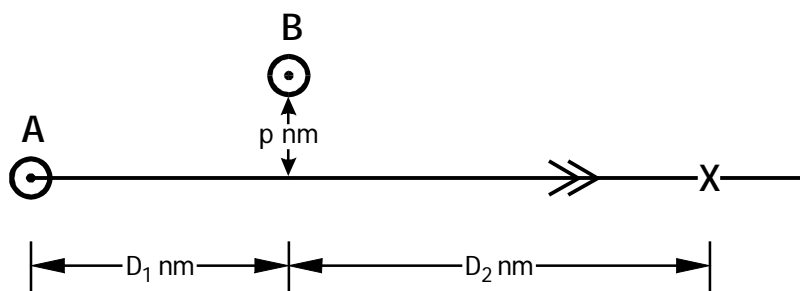


Figure 36

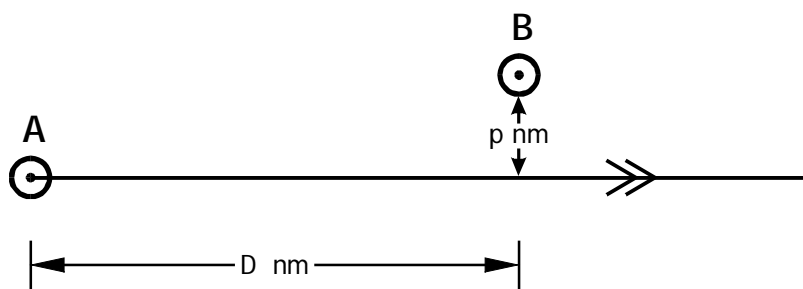
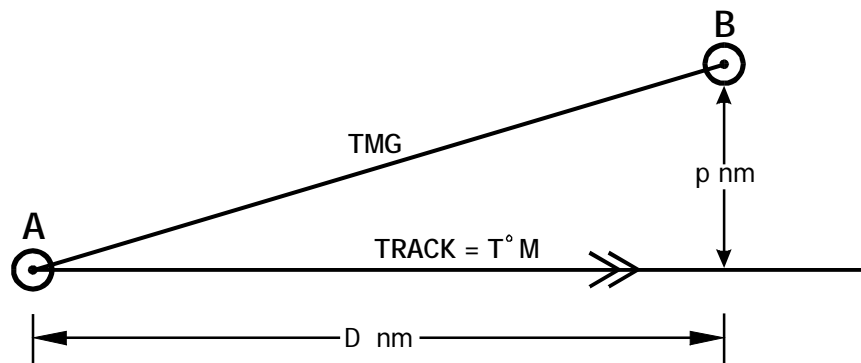
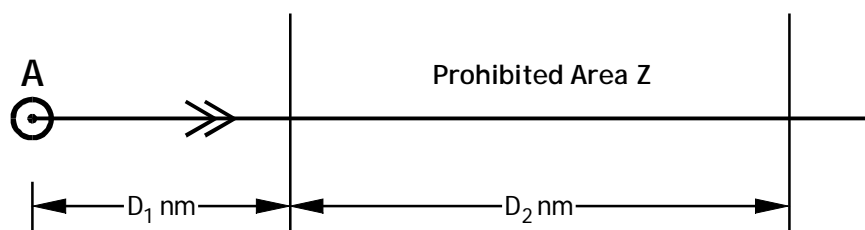


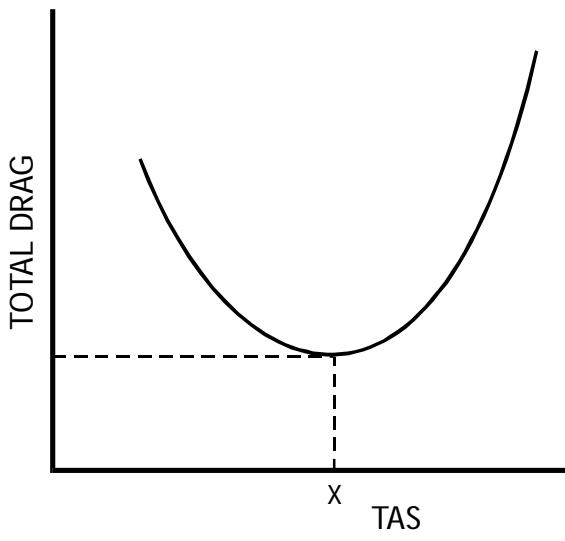
Figure 37



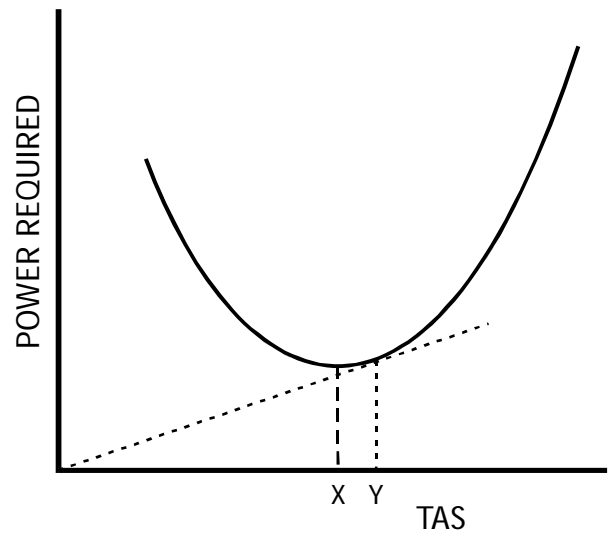
**Figure 38**



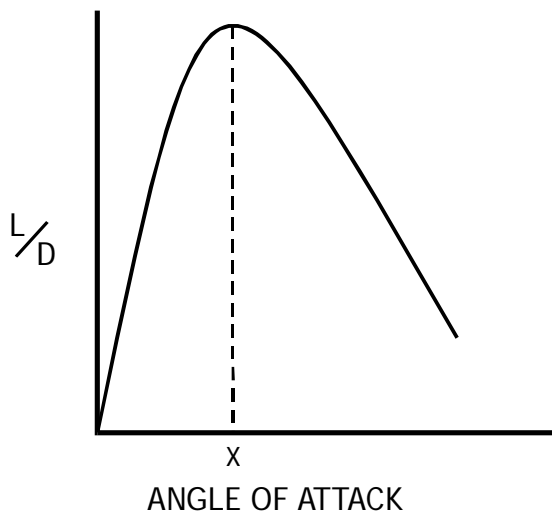
**Figure 39**



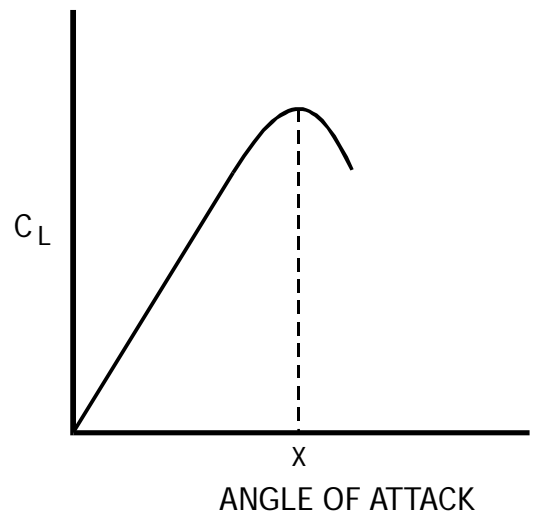
**Figure 40**



**Figure 41**

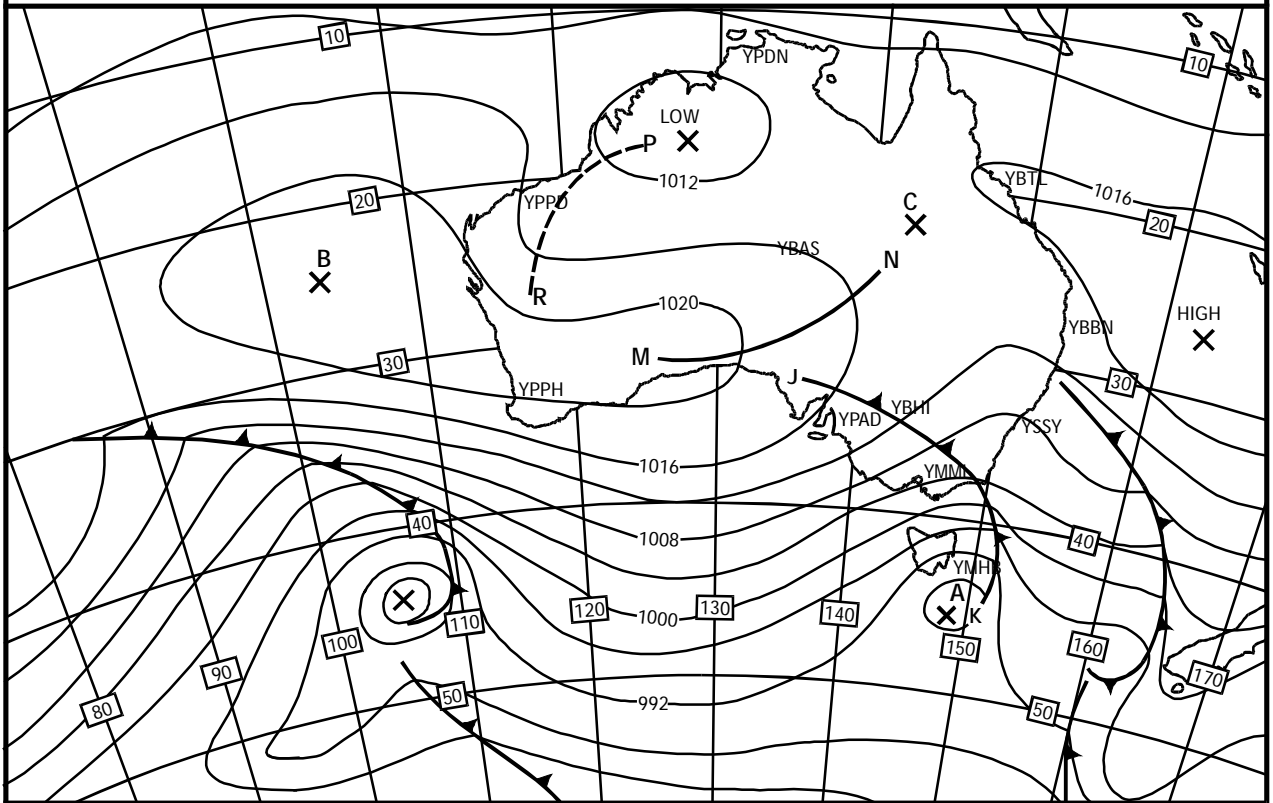


**Figure 42**

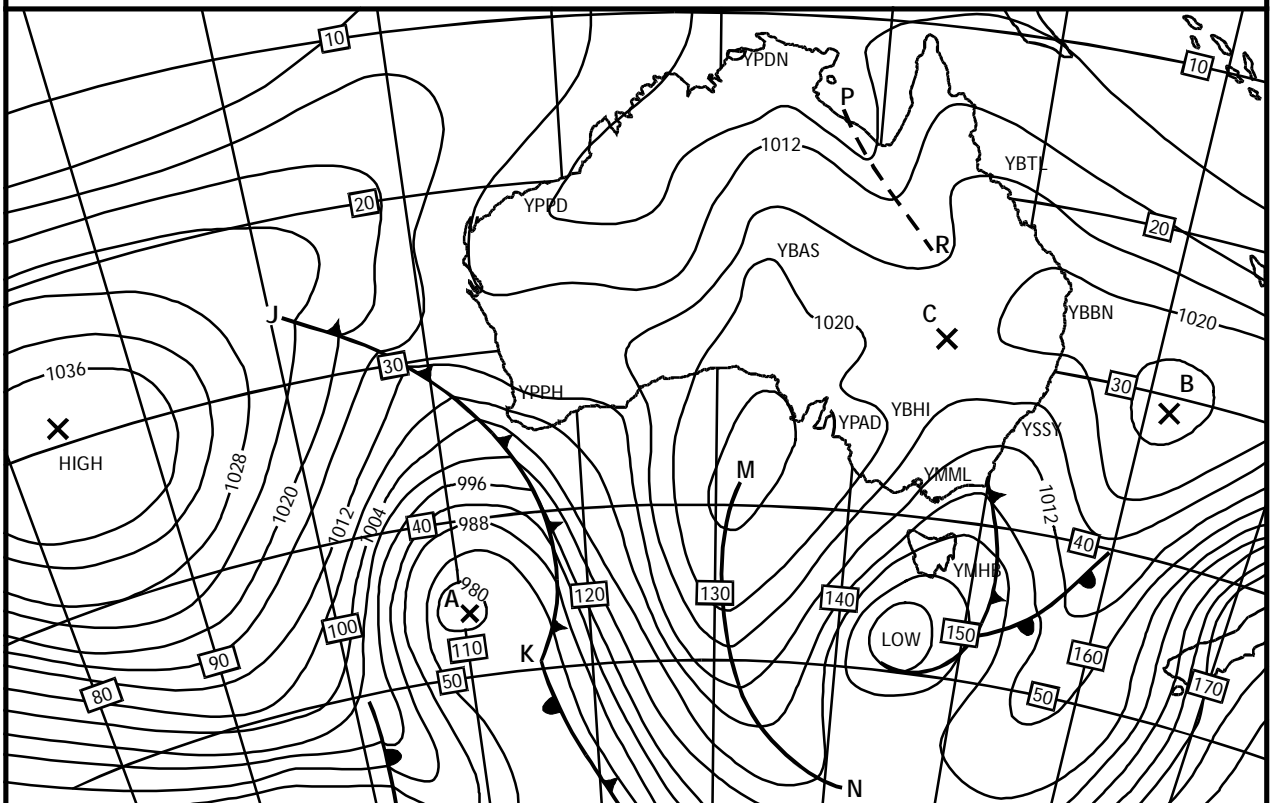


**Figure 43**

MSL ANALYSIS - Figure 48



MSL ANALYSIS - Figure 49



MSL ANALYSIS - Figure 49

